

SCMC N

Recommendations
Empfehlungen
Rekommendationer

Page: Seite: Sida:
B12-B14, B18

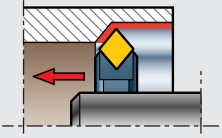



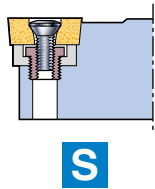

50°

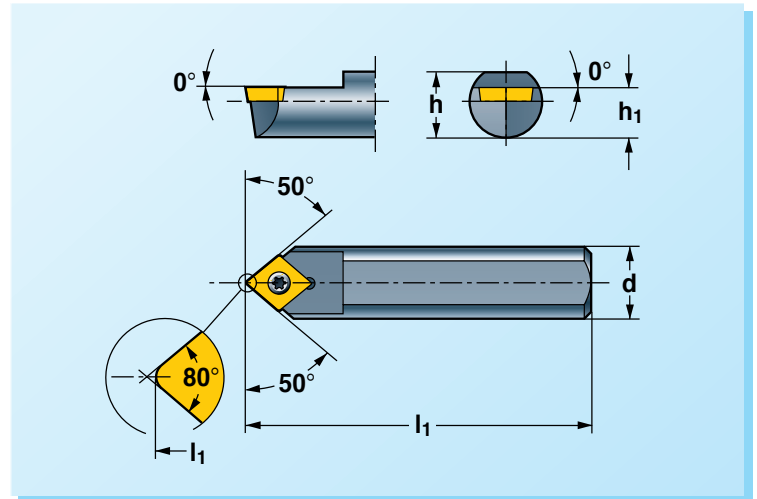

The drawing shows right-hand version. Left-hand version reversed.
Die Zeichnung zeigt Rechtsausführung. Linksausführung umgekehrt.
Ritningen visar högerutförande. Vänsterutförande spegelvänt.



B

	h ₁	h	d h ₈	f	l ₁		 torx	CCMW * CCMT CCXT   	Page: Seite: Sida: B179-B184
S08A-SCMC N 06	6	7	8	–	32	FTX072505	NY7X	0602 . .	
S10C-SCMC N 06	7	9	10	–	50				
S12D-SCMC N 09	8	11	12	–	60	FTX153507	NY15X	0903 . .	

SCDC R/L

Recommendations
Empfehlungen
Rekommendationer

Page: Seite: Sida:
B12-B14, B18

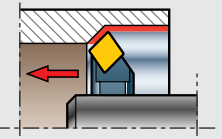



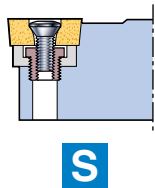

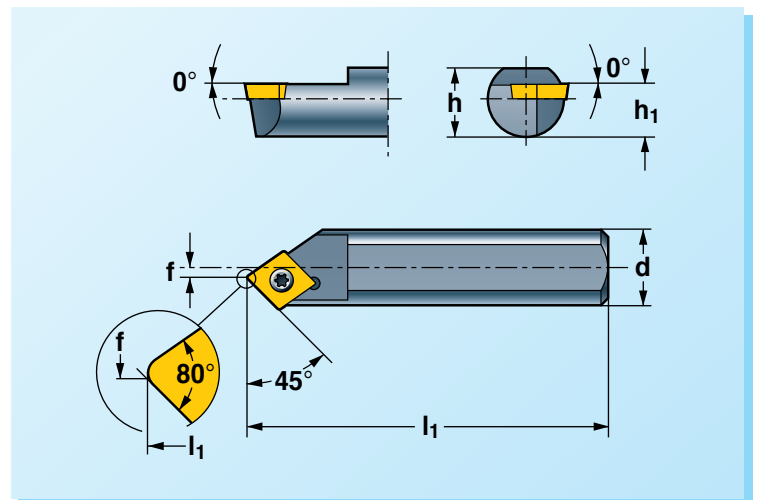

45°



The drawing shows right-hand version. Left-hand version reversed.
Die Zeichnung zeigt Rechtsausführung. Linksausführung umgekehrt.
Ritningen visar högerutförande. Vänsterutförande spegelvänt.



	h ₁	h	d h ₈	f	l ₁		 torx	CCMW * CCMT CCXT   	Page: Seite: Sida: B179-B184
S08A-SCDC R/L 06	6	7	8	0,3	32	FTX072505	NY7X	0602 . .	
S10C-SCDC R/L 06	7	9	10	1,2	50				
S12D-SCDC R/L 09	8	11	12	0,45	60	FTX153507	NY15X	0903 . .	

*  Selection of cutting geometry page:
Wahl der Schneidgeometrie, Seite: **B27-B39**
 Val av skärgeometri, sid:

Ordering example:
Bestellbeispiel: **S08A-SCDC 06**
Beställningsexempel:

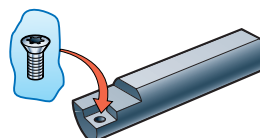



Spare parts shown in the coloured columns are supplied assembled in each tool.

Die in den farbigen Spalten aufgeführten Ersatzteile sind in den Werkzeugen montiert.

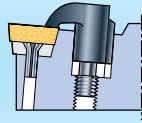
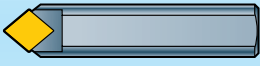
Reservdelar i de färgade kolumnerna ingår monterade i varje verktyg.

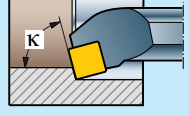

B

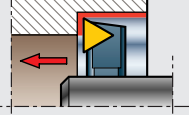
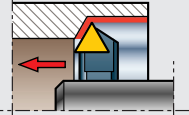
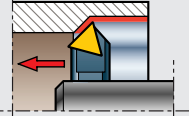
								Page Seite Sida
		8	10	12	16	20		
 90°	CTAC R/L		06					B127
	CTAP R/L			09	11	11	16	B127
 60°	CTEC R/L		06					B127
	CTEP R/L			09	11	11	16	B127
 45°	CTDC R/L		06					B128
	CTDP R/L			09	11	11	16	B128

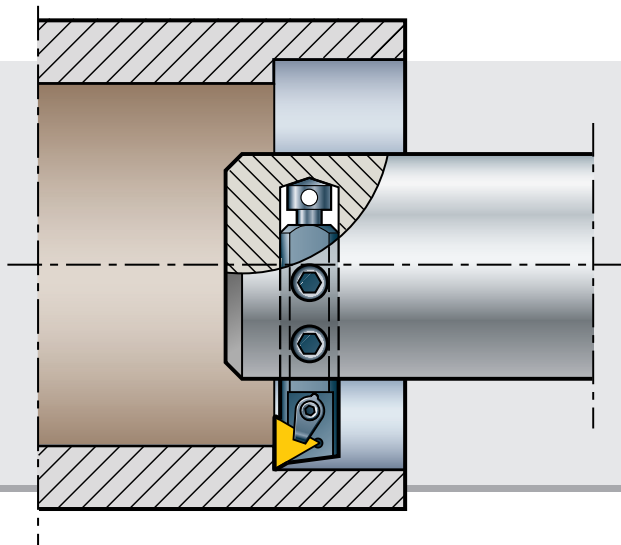

CTAC R/L
CTAP R/L

Recommendations
Empfehlungen
Rekomendationer

Page: Seite: Sida:

B12-B14, B19

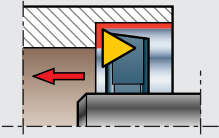

90°

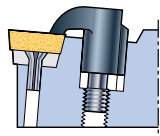





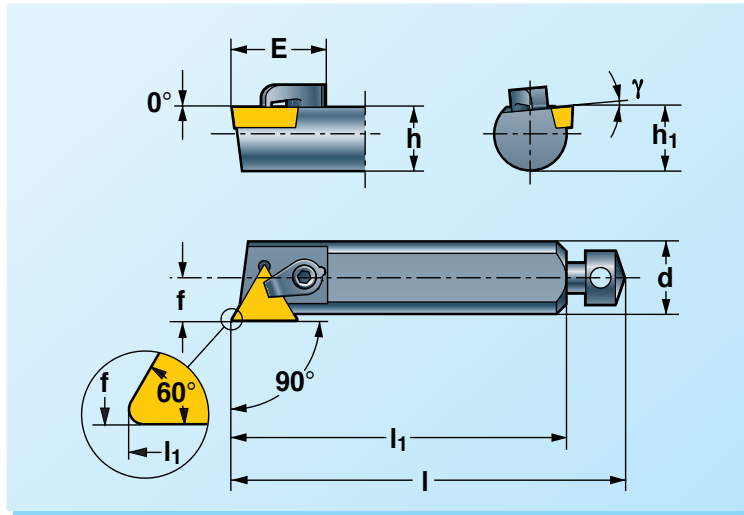



C

The drawing shows right-hand version. Left-hand version reversed.
Die Zeichnung zeigt Rechtsausführung. Linksausführung umgekehrt.
Ritningen visar högerutförande. Vänsterutförande spegelvänt.



B

			$h=h_1$	d	l_{max} l_{min}	l_1	E	f	γ							TCGR TPGN TPGR TPMR	Page: Seite: Sida: B185, B192
S08X-CTAC R/L 06 S10X-CTAP R/L 09			7 9	8 10	— —	30 50	14 15,2	4 5	2° 6°	—	—	SH49	6S-50K	NY1.5	—	0601 . . 0902 . .	
S12X-CTAP R/L 11 S16X-CTAP R/L 11			10,5 14	12 16	67 63 97 93	57 87	16,9 16	6,5 8,5	6° 6°	—	—	SH50M	6S-50M	NY2	AX508	1103 . .	
S20X-CTAP R/L 16			17	20	127 123	117	21,1	10,7	6°	U323S	RS2	SH51	6S61	NY3	AX508	1603 . .	

CTEC R/L
CTEP R/L

Recommendations
Empfehlungen
Rekomendationer

Page: Seite: Sida:

B12-B14, B19

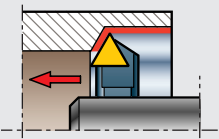



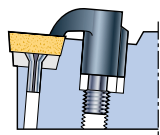



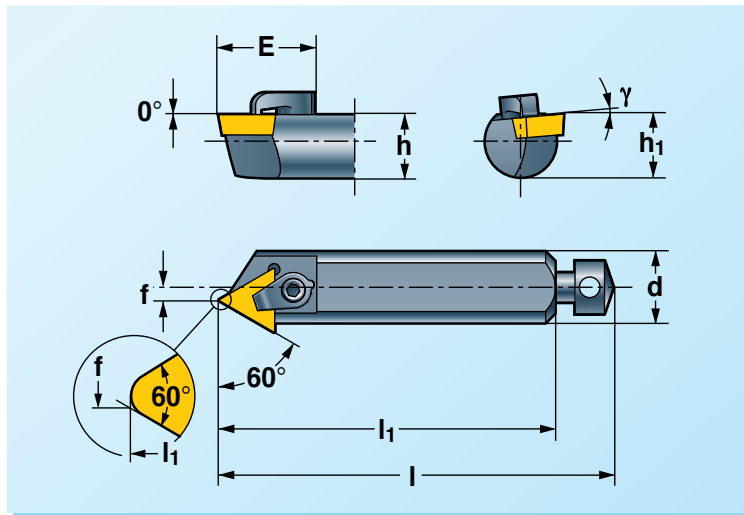

60°



C

The drawing shows right-hand version. Left-hand version reversed.
Die Zeichnung zeigt Rechtsausführung. Linksausführung umgekehrt.
Ritningen visar högerutförande. Vänsterutförande spegelvänt.



			$h=h_1$	d	l_{max} l_{min}	l_1	E	f	γ							TCGR TPGN TPGR TPMR	Page: Seite: Sida: B185, B192
S08X-CTEC R/L 06 S10X-CTEP R/L 09			7 9	8 10	— —	30 50	14,5 16,7	1,4 1,5	2° 6°	—	—	SH49	6S-50K	NY1.5	—	0601 . . 0902 . .	
S12X-CTEP R/L 11 S16X-CTEP R/L 11			10,5 14	12 16	67 63 97 93	57 87	19 19	2,4 2,4	6° 6°	—	—	SH50M	6S-50M	NY2	AX508	1103 . .	
S20X-CTEP R/L 16			17	20	127 123	117	25	1,9	6°	U323S	RS2	SH51	6S61	NY3	AX508	1603 . .	

Ordering example:
Bestellbeispiel: **S12X-CTEP L 11**
Beställningsexempel:

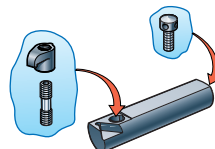

Spare parts shown in the coloured columns are supplied assembled in each tool.

Die in den farbigen Spalten aufgeführten Ersatzteile sind in den Werkzeugen montiert.

Reservdelar i de färgade kolumnerna ingår monterade i varje verktyg.

CTDC R/L
CTDP R/L

Recommendations
Empfehlungen
Rekommendationer

Page: Seite: Sida:

B12-B14, B19

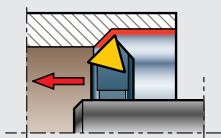



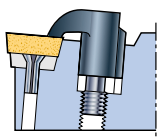



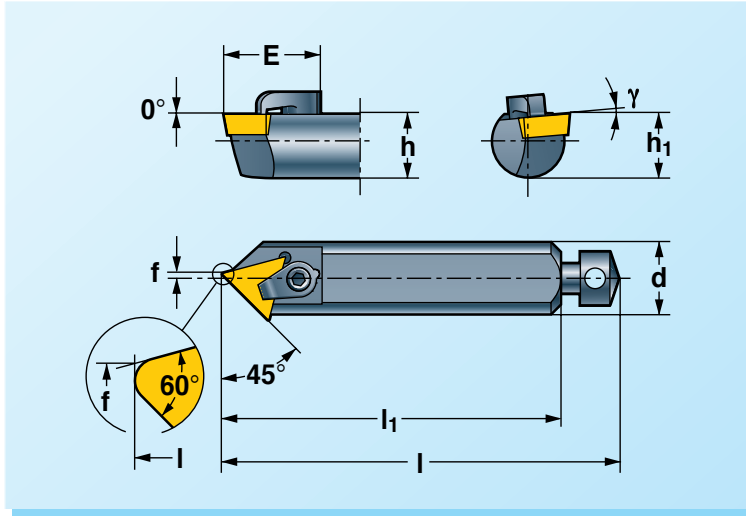

45°



C

B The drawing shows right-hand version. Left-hand version reversed.
Die Zeichnung zeigt Rechtsausführung. Linksausführung umgekehrt.
Ritningen visar högerutförande. Vänsterutförande spegelvänt.



			$h=h_1$	d	l_{\max} l_{\min}	l_1	E	f	γ							TCGR TPGN TPGR TPMR	Page: Seite: Sida: B185, B192
S08X-CTDC R/L 06 S10X-CTDP R/L 09			7 9	8 10	— —	30 50	15 16,8	0,2 0,6	2° 6°	—	—	SH49	6S-50K	NY1.5	—	0601 .. 0902 ..	
S12X-CTDP R/L 11 S16X-CTDP R/L 11			10,5 14	12 16	67 63 97 93	57 87	19,7 19,7	0,2 0,2	6° 6°	—	—	SH50M	6S-50M	NY2	AX508	1103 ..	
S20X-CTDP R/L 16			17	20	127 123	117	24,8	0,9	6°	U323S	RS2	SH51	6S61	NY3	AX508	1603 ..	

Ordering example:
Bestellbeispiel: **S10X-CTDP L 09**
Beställningsexempel:

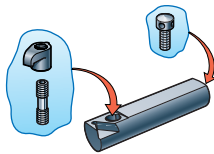

Spare parts shown in the coloured columns are supplied assembled in each tool.

Die in den farbigen Spalten aufgeführten Ersatzteile sind in den Werkzeugen montiert.

Reservdelar i de färgade kolumnerna ingår monterade i varje verktyg.

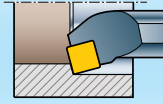

Type of tool Werkzeugtyp Verktygstyp	Shank diameter Shaftdurchmesser Skaftdiameter	Length of tool Werkzeu- länge Verktygs- längd	Clamping system Spann- system Spänn- system	Shape of insert Schneidform Skärform	Approach angle and type Einstellwinkel und Typ Ställvinkel och typ	Relief angle of insert Freiwinkel der Schneide Skärets släpp- ningsvinkel	Performance Ausführung Utförande	Length of cutting edge Sneidkanten- länge Skärkants- längd	Additional code Zusatzcode Tilläggskod																																																
S	32	T-	P	T	F	N	R	16	..																																																
<p>A = Steel shank with through coolant</p> <p>S = Steel shank</p> <p>E = Hard metall shank with brazed insert seat of steel</p> <p>A = Stahlschaft mit innerer Kühlmittelzufuhr</p> <p>S = Stahlschaft</p> <p>E = Hartmetallschaft mit festgelötetem Schneidsitz aus Stahl</p> <p>A = Stålbom med invändig kylvätsketillförsel</p> <p>S = stålskaft</p> <p>E = hårdmetallskaft med fastlött skärläge i stål</p>	<p>d</p> <p>08 10 12 16 20 25 32 40 50 60</p>	<p>l₁</p> <table border="1"> <thead> <tr> <th>l₁ mm</th> <th>Symbol</th> </tr> </thead> <tbody> <tr><td>32</td><td>A</td></tr> <tr><td>40</td><td>B</td></tr> <tr><td>50</td><td>C</td></tr> <tr><td>60</td><td>D</td></tr> <tr><td>70</td><td>E</td></tr> <tr><td>80</td><td>F</td></tr> <tr><td>90</td><td>G</td></tr> <tr><td>100</td><td>H</td></tr> <tr><td>110</td><td>J</td></tr> <tr><td>125</td><td>K</td></tr> <tr><td>140</td><td>L</td></tr> <tr><td>150</td><td>M</td></tr> <tr><td>160</td><td>N</td></tr> <tr><td>170</td><td>P</td></tr> <tr><td>180</td><td>Q</td></tr> <tr><td>200</td><td>R</td></tr> <tr><td>250</td><td>S</td></tr> <tr><td>300</td><td>T</td></tr> <tr><td>350</td><td>U</td></tr> <tr><td>400</td><td>V</td></tr> <tr><td>450</td><td>W</td></tr> <tr><td>500</td><td>Y</td></tr> <tr><td>Spec</td><td>X</td></tr> </tbody> </table>	l ₁ mm	Symbol	32	A	40	B	50	C	60	D	70	E	80	F	90	G	100	H	110	J	125	K	140	L	150	M	160	N	170	P	180	Q	200	R	250	S	300	T	350	U	400	V	450	W	500	Y	Spec	X	<p>C</p> <p>Clamp Spannhaken Spännhake</p> <p>M</p> <p>Locking pin/hole and clamp</p> <p>Spannstift/ Loch und Spannhaken</p> <p>Pinne/hål och spänn- hake</p> <p>P</p> <p>Locking pin/hole</p> <p>Spannstift/ Loch</p> <p>Pinne/hål</p> <p>S</p> <p>Screw/hole Schraube/ Loch Skruv/hål</p>	<p>H</p> <p>O</p> <p>P</p> <p>R</p> <p>S</p> <p>T</p> <p>C</p> <p>80°</p> <p>D</p> <p>55°</p> <p>E</p> <p>75°</p> <p>M</p> <p>86°</p> <p>V</p> <p>35°</p> <p>W</p> <p>80°</p> <p>L</p> <p>A</p> <p>85°</p> <p>B</p> <p>82°</p> <p>K</p> <p>55°</p>	<p>F</p> <p>90°</p> <p>K</p> <p>75°</p> <p>L</p> <p>95°</p> <p>Q</p> <p>107,5°</p> <p>S</p> <p>45°</p> <p>U</p> <p>93°</p> <p>W</p> <p>60°</p> <p>X</p> <p>Spec. 85°</p>	<p>A</p> <p>3°</p> <p>B</p> <p>5°</p> <p>C</p> <p>7°</p> <p>D</p> <p>15°</p> <p>E</p> <p>20°</p> <p>F</p> <p>25°</p> <p>G</p> <p>30°</p> <p>N</p> <p>0°</p> <p>P</p> <p>11°</p> <p>Y</p> <p>85°</p>	<p>R</p> <p>R=right-hand R=rechts R=höger</p> <p>L</p> <p>L=left-hand L=links L=vänster</p>	<p>H</p> <p>O</p> <p>P</p> <p>R</p> <p>S</p> <p>T</p> <p>C,D,E M,V</p> <p>W</p> <p>L</p> <p>A,B,K</p>	<p>Additional code examples:</p> <p>M = MIRCONA standard tool holder (apart from ISO)</p> <p>Tool holders for ceramic inserts; C = Chip breaker P = Thrust plate R = Round shank EB = Holder for micro lubrication</p> <p>Beispiel von Zusatzcode:</p> <p>M = MIRCONA Standardhalter über ISO hinaus</p> <p>Klemmhalter für keramische Wendeschneidplatten; C = Spanbrecher P = Druckplatte R = Runde shaft EB = Halter für Minimalschmierung</p> <p>Exempel på tilläggskod:</p> <p>M = MIRCONA standardhållare utöver ISO</p> <p>Verktygshållare för keramiska skär; C = Spånbreakare P = Tryckplatta R = Runt skaft EB = Hållare för minimalsmjörning</p>
l ₁ mm	Symbol																																																								
32	A																																																								
40	B																																																								
50	C																																																								
60	D																																																								
70	E																																																								
80	F																																																								
90	G																																																								
100	H																																																								
110	J																																																								
125	K																																																								
140	L																																																								
150	M																																																								
160	N																																																								
170	P																																																								
180	Q																																																								
200	R																																																								
250	S																																																								
300	T																																																								
350	U																																																								
400	V																																																								
450	W																																																								
500	Y																																																								
Spec	X																																																								



Measures and tolerances to ISO, see page B101.

Massen und Toleranzen nach ISO, siehe Seite B101.

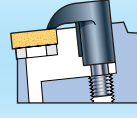
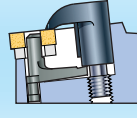
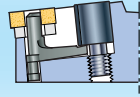
Mått och toleanser enligt ISO, se sid B101.

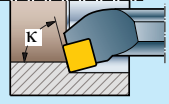
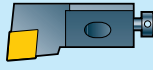

B

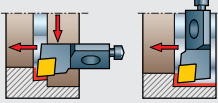
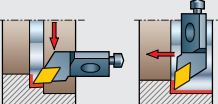
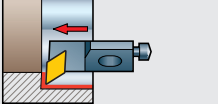
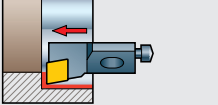
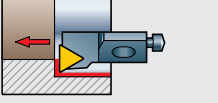
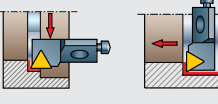
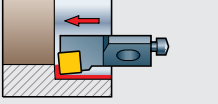
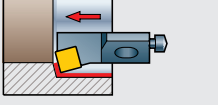
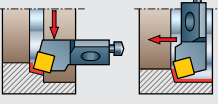
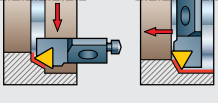
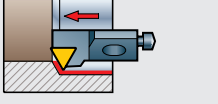
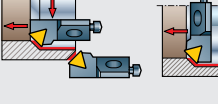
						Page Seite Sida
		16	20	25		
 95°	PCLN R/L MCLN R/L CCLN R/L	12	12		B132	
 93°	PDJN R/L MDJN R/L CDJN R/L			15	B132	
 93°	PDUN R/L MDUN R/L CDUN R/L			15	B133	
 90°	PCFN R/L MCFN R/L CCFN R/L	12			B133	
 90°	PTFN R/L MTFN R/L CTFN R/L	16	16		B134	
 90°	PTGN R/L MTGN R/L CTGN R/L	16	16		B134	
 85°	PSYN R/L MSYN R/L CSYN R/L	12	12		B135	
 75°	PSKN R/L MSKN R/L CSKN R/L	12	12		B135	
 75°	PSRN R/L MSRN R/L CSRN R/L	12	12		B136	
 60°	PTTN R/L MTTN R/L CTTN R/L	16	16		B136	
 60°	PTWN R/L MTWN R/L CTWN R/L	16	16		B137	
 45°	PTSN R/L MTSN R/L CTSN R/L	16	16		B137	

Please note:

Holders in **M-style** **must** be used in combination with throw-away inserts which have an **insert height** according to **ISO** standard at the contact surface between the top of the clamp and the insert. If that would not be the case, as for example when using special cutting geometries with a pronounced positive rake angle, the top of the clamp will not touch the upper side of the insert and thereby the function of the **M-clamping** set will be negated.

Bitte beachten:

Halter in **M-Ausführung** dürfen **nur in Kombination** mit Wendschneidplatten eingesetzt werden, deren **Höhe** zwischen Auflage und Spannfläche **ISO-Standard** entspricht.

Wenn dies nicht gegeben ist, wie z B bei einigen speziellen Schneidengeometrien mit betont positivem Spanwinkel, berührt die Spannhakenöse die Oberseite der Schneidplatte nicht. Dadurch wird die Funktion des **M-Spannsatzes** vereitelt.

Observera:

Hållare i **M-utförande** **måste** användas i kombination med vändskär som har en **skärhöjd** enligt **ISO-standard** vid spannhakensnosens anliggningsyta. Om så ej är fallet, som t ex vid användande av speciella skärgeometrier med uttalat positiv spänvinkel, kommer spannhakens nos ej i kontakt med skärets översida och därmed omintetgörs **M-spännsatzens** funktion.

Holders with **P-** and **M-clamping** are stocked in accordance with the range shown in the catalogue.

Holders with **C-clamping** in the **PMC-range** are not stocked. The **C-holder** is obtained in the following way:

- From the **P-holder**:

Remove the locking pin (LP) and change the clamping set (PS) for the clamping set MS in accordance with the sketch on page B16. The spare part designation on the clamping set (MS) is obtained from the table on corresponding holder size in **M-version**.

- From the **M-holder**:

Remove the locking pin (LP) in accordance with sketch on page B16.

The MIRCONA PMC system is patented and patent pending in many countries.

Halter mit **P-** und **M-Spannsystem** werden am Lager gehalten entsprechend der Aufstellung, die im Katalog gezeigt wird.

Halter mit **C-Spannsystem** werden in der **PMC-Produktpalette** nicht am Lager gehalten. Die **C-Ausführung** erhält man wie folgt:

- Aus dem **P-Halter**:

Entfernen Sie den Spannstift (LP) und wechseln Sie den Spannsatz (PS) gegen den Spannsatz (MS) entsprechend der Skizze auf Seite B16. Die Ersatzteilbeschreibung des Spannfingers (MS) erhalten Sie aus der Tabelle für die entsprechende Haltergröße in **M-Ausführung**.

- Aus dem **M-Halter**:

Entfernen Sie den Spannstift (LP) entsprechend der Skizze auf Seite B16.

Das MIRCONA PMC-system ist in mehreren Ländern patentiert und zum Patent angemeldet.

Hållare med **P-** och **M-fastspänning** lagerföres i överensstämmelse med sortimentet i katalogen.

Hållare med **C-fastspänning** i **PMC-sortimentet** lagerföres ej. **C-utförandet** erhålles på följande sätt:

Ifrån **P-hållaren**:

Ta bort låspinnen (LP) och byt spännsats (PS) mot spännsats (MS) enl skiss på sid B16. Reservdelsbe-teckningen på spännsats (MS) erhålles ifrån tabellen på motsvarande hållarstorlek i **M-utförande**.

- Ifrån **M-hållaren**:

Ta bort låspinnen (LP) enl skiss på sid B16.

MIRCONA PMC-system är patenterat och patent-sökt i ett flertal länder.

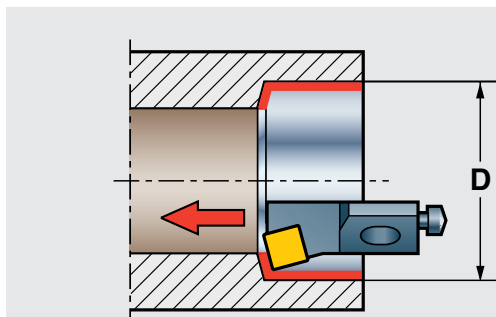
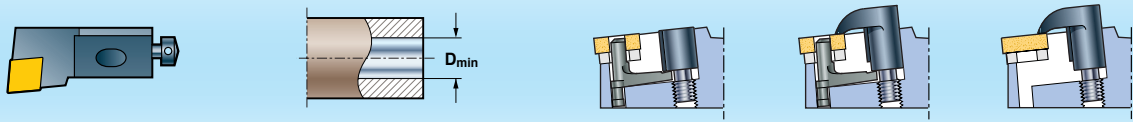

Size Grösse Storlek	16 CA	20 CA	25 CA
Type	P/M/C SKN	P/M/C SKN	P/M/C –
Typ	SYN	SYN	–
Typ	TFN	TFN	–
Typ	TSN	TSN	–
Typ	TWN	TWN	–
Typ	CLN	CLN	–
	–	–	DUN
	CFN	–	–
D-min	60	70	100

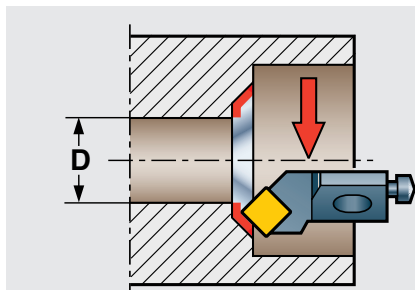

Size Grösse Storlek	16 CA	20 CA	25 CA
Type	P/M/C SRN	P/M/C SRN	P/M/C –
Typ	TGN	TGN	–
Typ	TSN	TSN	–
Typ	TTN	TTN	–
Typ	CLN	CLN	–
	–	–	DJN
D-min	60	70	100

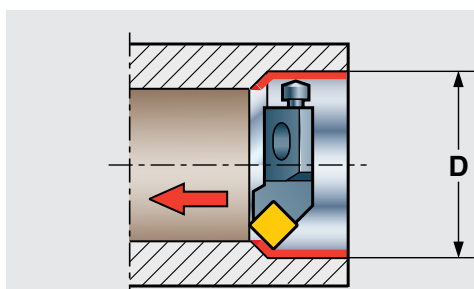

Size Grösse Storlek	16 CA	20 CA	25 CA
Type	P/M/C SRN	P/M/C SRN	P/M/C –
Typ	TGN	TGN	–
Typ	TSN	TSN	–
Typ	TTN	TTN	–
Typ	CLN	CLN	–
	–	–	DJN
D-min	75	90	115

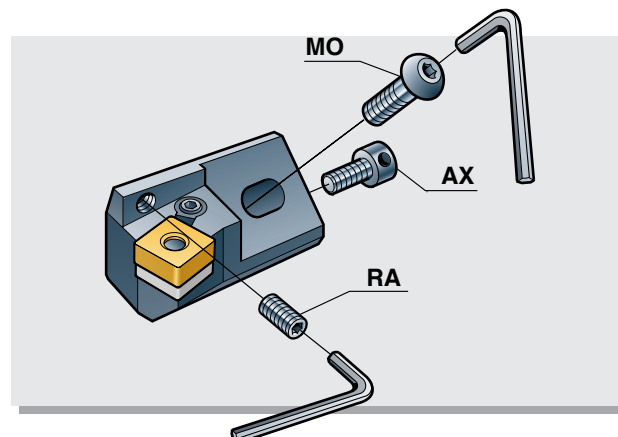

B

PDUN R/L
MDUN R/L
CDUN R/L

Recommendations
Empfehlungen
Rekommendationer

Page: Seite:
Sida: **B12-B17**

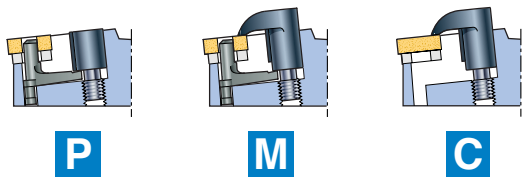

The drawing shows right-hand version. Left-hand version reversed.
Die Zeichnung zeigt Rechtsausführung. Linksausführung umgekehrt.
Ritningen visar högerutförande. Vänsterutförande spegelvänt.

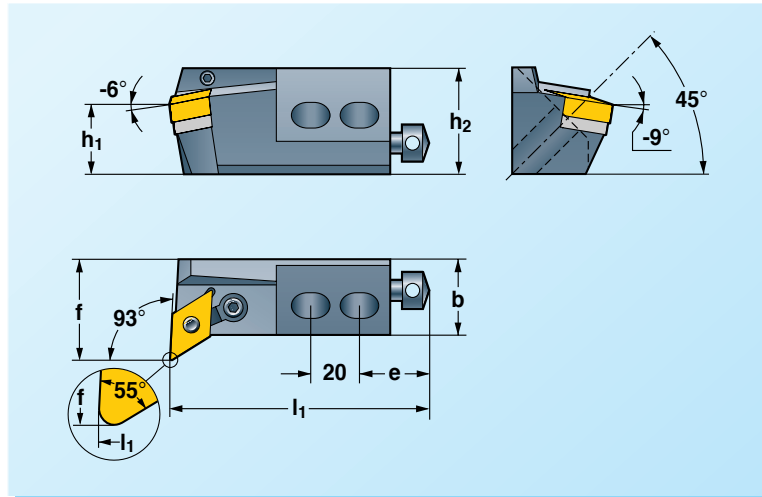

		h_1	h_2	b	l_1	e	f													DNMA * DNMG DNMM	Page: Seite: Sida: B172-B178
P	PDUN R/L 25CA-15T	25	38	25	100	30	32	LP62-1T	UDN15 ¹⁾ (UDN154) ²⁾	RS62	D62	PS62	-	NY4	AX813	RA608	NY3	MO1040	NY6	1506 .. ¹⁾ (1504 ..) ²⁾	
M	MDUN R/L 25CA-15T	25	38	25	100	30	32	LP62-1T	UDN15 ¹⁾ (UDN154) ²⁾	RS62	D62	-	MS63	NY4	AX813	RA608	NY3	MO1040	NY6	1506 .. ¹⁾ (1504 ..) ²⁾	
C	CDUN R/L	See page - Siehe Seite - Se sida B16-B17																			

PCFN R/L
MCFN R/L
CCFN R/L

Recommendations
Empfehlungen
Rekommendationer

Page: Seite:
Sida: **B12-B17**

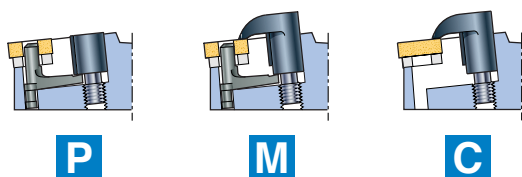

The drawing shows right-hand version. Left-hand version reversed.
Die Zeichnung zeigt Rechtsausführung. Linksausführung umgekehrt.
Ritningen visar högerutförande. Vänsterutförande spegelvänt.

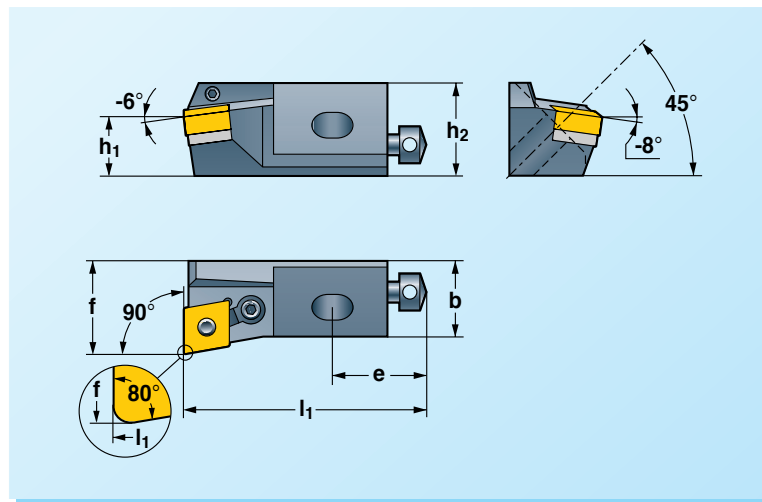

		h_1	h_2	b	l_1	e	f													CNMA * CNMG CNMM	Page: Seite: Sida: B172-B178
P	PCFN R/L 16CA-12	16	25	20	63	25	25	LP62K	UCN12	RS62	D62	PS62	-	NY4	AX612	RA508	NY2.5	MO830	NY5	1204 ..	
M	MCFN R/L 16CA-12	16	25	20	63	25	25	LP62K	UCN12	RS62	D62	-	MS63	NY4	AX612	RA508	NY2.5	MO830	NY5	1204 ..	
C	CCFN R/L	See page - Siehe Seite - Se sida B16-B17																			

¹⁾ Standard delivery for inserts with 6,35 mm thickness.

²⁾ Separate delivery for inserts with 4,76 mm thickness.

¹⁾ Standardlieferung für Schneiden mit 6,35 mm Dicke.

²⁾ Lieferung auf besondere Bestellung für Schneiden mit 4,76 mm Dicke.

¹⁾ Standardleverans för skär med 6,35 mm tjocklek.

²⁾ Separat leverans för skär med 4,76 mm tjocklek.

PTFN R/L
MTFN R/L
CTFN R/L

Recommendations
Empfehlungen
Rekommendationer

Page: Seite: **B12-B17**
Sida:

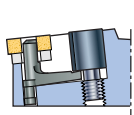
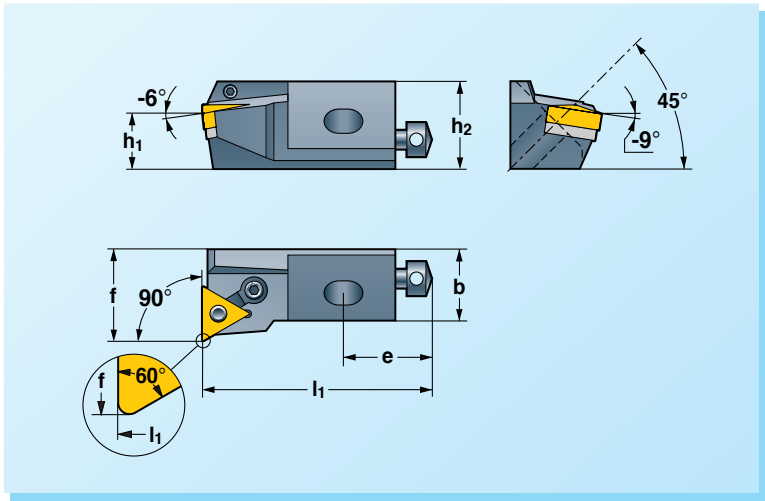

P

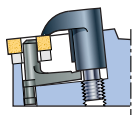

M

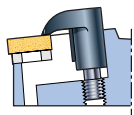

C

B The drawing shows right-hand version. Left-hand version reversed.
Die Zeichnung zeigt Rechtsausführung. Linksausführung umgekehrt.
Ritningen visar högerutförande. Vänsterutförande spegelvänt.

			h_1	h_2	b	l_1	e	f												TNMA *	TNMG	TNMM	Page: Seite: B172-B178 Sida:
P	PTFN R/L 16CA-16	PTFN R/L 20CA-16	16	25	20	63	25	25	LP61	UTN16-1	RS61K	D61	PS61	-	NY3	AX612	RA508	NY2.5	MO830	NY5	1604 ..		
M	MTFN R/L 16CA-16	MTFN R/L 20CA-16	16	25	20	63	25	25	LP61	UTN16-1	RS61K	D61	-	MS61	NY3	AX612	RA508	NY2.5	MO830	NY5	1604 ..		
C	CTFN R/L		See page	-	Siehe Seite	-	Se sida	B16-B17															

PTGN R/L
MTGN R/L
CTGN R/L

Recommendations
Empfehlungen
Rekommendationer

Page: Seite: **B12-B17**
Sida:

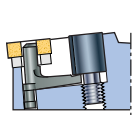
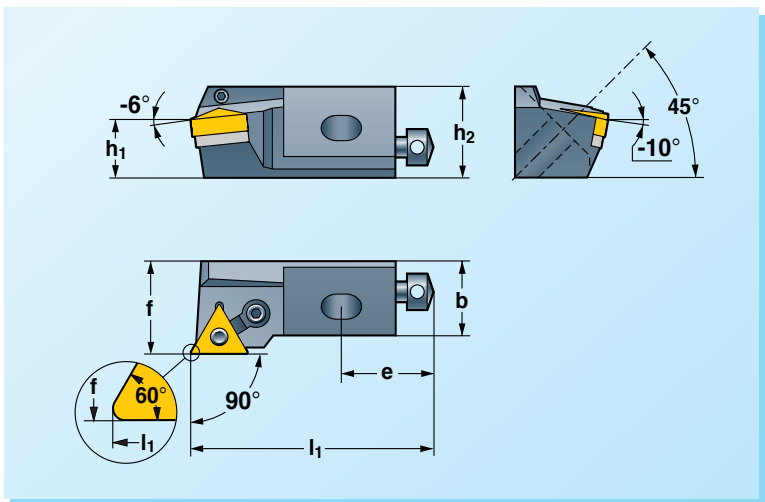

P

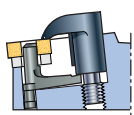

M

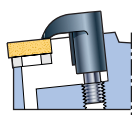

C

The drawing shows right-hand version. Left-hand version reversed.
Die Zeichnung zeigt Rechtsausführung. Linksausführung umgekehrt.
Ritningen visar högerutförande. Vänsterutförande spegelvänt.

			h_1	h_2	b	l_1	e	f												TNMA *	TNMG	TNMM	Page: Seite: B172-B178 Sida:
P	PTGN R/L 16CA-16	PTGN R/L 20CA-16	16	25	20	63	25	25	LP61	UTN16-1	RS61K	D61	PS61	-	NY3	AX612	RA508	NY2.5	MO830	NY5	1604 ..		
M	MTGN R/L 16CA-16	MTGN R/L 20CA-16	16	25	20	63	25	25	LP61	UTN16-1	RS61K	D61	-	MS61	NY3	AX612	RA508	NY2.5	MO830	NY5	1604 ..		
C	CTGN R/L		See page	-	Siehe Seite	-	Se sida	B16-B17															

PSRN R/L
MSRN R/L
CSRN R/L

Recommendations
Empfehlungen
Rekomendationer

Page: Seite: **B12-B17**

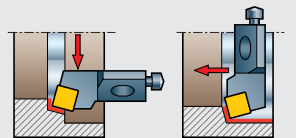

75°

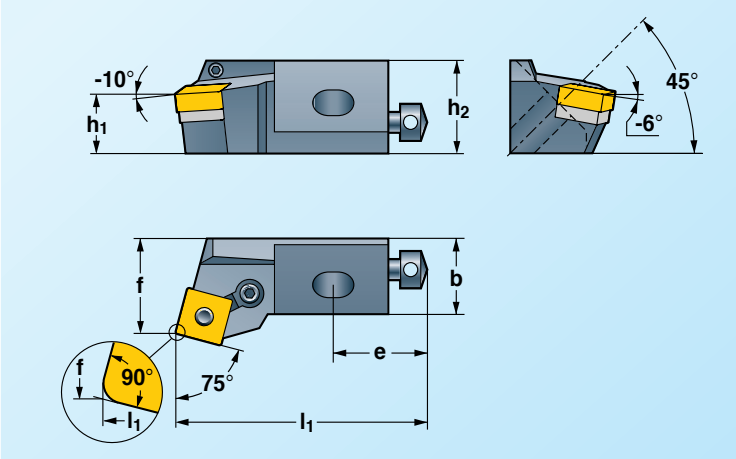
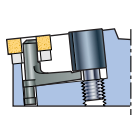
P



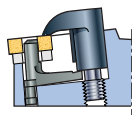



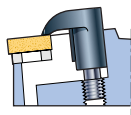



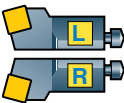







M



C

B The drawing shows right-hand version. Left-hand version reversed.
Die Zeichnung zeigt Rechtsausführung. Linksausführung umgekehrt.
Ritningen visar högerutförande. Vänsterutförande spegelvänt.

			h_1	h_2	b	l_1	e	f													SNMA * 	SNMG 	SNMM 	Page: Seite: B172-B178 Sida:	
P	PSRN R/L 16CA-12	PSRN R/L 20CA-12	16	25	20	63	25	25	LP62K-1 LP62K	USN12	RS62	D62	PS62	-	NY4	AX612	RA508	NY2.5	MO830	NY5	1204 ..				
M	MSRN R/L 16CA-12	MSRN R/L 20CA-12	16	25	20	63	25	25	LP62K-1 LP62K	USN12	RS62	D62	-	MS62	NY4	AX612	RA508	NY2.5	MO830	NY5	1204 ..				
C	CSRN R/L	See page - Siehe Seite - Se sida																					B16-B17		

PTTN R/L
MTTN R/L
CTTN R/L

Recommendations
Empfehlungen
Rekomendationer

Page: Seite: **B12-B17**

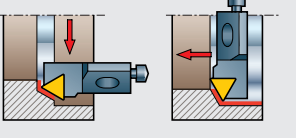

60°

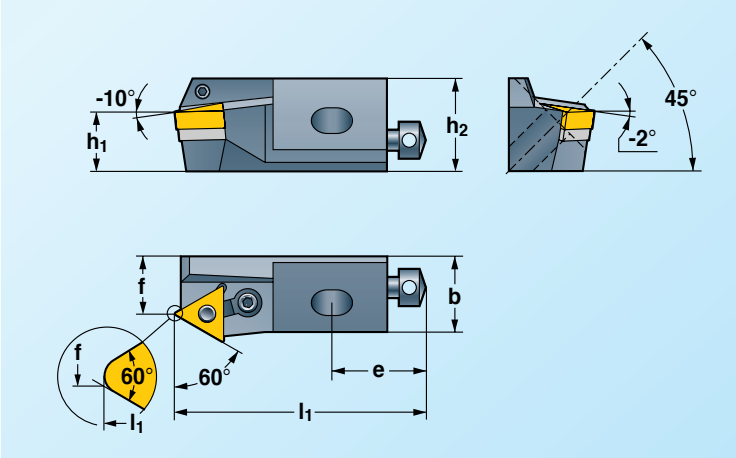
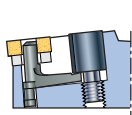
P

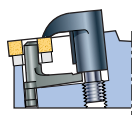

M

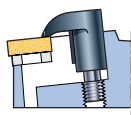

C

The drawing shows right-hand version. Left-hand version reversed.
Die Zeichnung zeigt Rechtsausführung. Linksausführung umgekehrt.
Ritningen visar högerutförande. Vänsterutförande spegelvänt.

			h_1	h_2	b	l_1	e	f													TNMA * 	TNMG 	TNMM 	Page: Seite: B172-B178 Sida:	
P	PTTN R/L 16CA-16	PTTN R/L 20CA-16	16	25	20	63	25	15	LP61	UTN16-1	RS61K	D61	PS61	-	NY3	AX612	RA508	NY2.5	MO830	NY5	1604 ..				
M	MTTN R/L 16CA-16	MTTN R/L 20CA-16	16	25	20	63	25	15	LP61	UTN16-1	RS61K	D61	-	MS61	NY3	AX612	RA508	NY2.5	MO830	NY5	1604 ..				
C	CTTN R/L	See page - Siehe Seite - Se sida																					B16-B17		

**PTWN R/L
MTWN R/L
CTWN R/L**

Recommendations
Empfehlungen
Rekommendationer

Page: Seite: **B12-B17**
Sida:

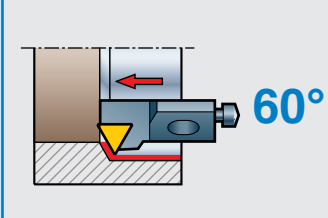
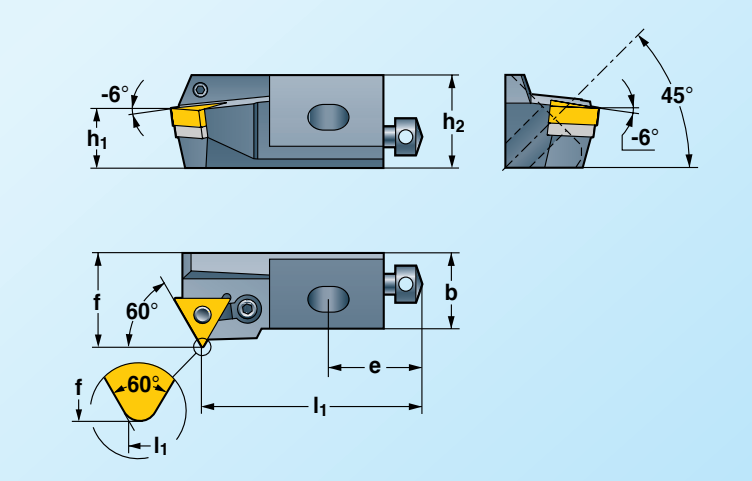
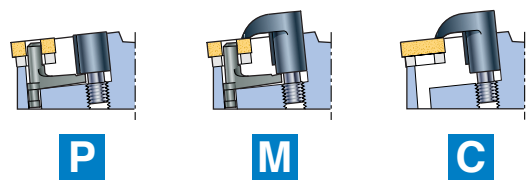
The drawing shows right-hand version. Left-hand version reversed.
Die Zeichnung zeigt Rechtsausführung. Linksausführung umgekehrt.
Ritningen visar högerutförande. Vänsterutförande spegelvänt.

			h_1	h_2	b	l_1	e	f													TNMA * TNMG TNMM Page: Seite: B172-B178 Sida:
P	PTWN R/L 16CA-16 PTWN R/L 20CA-16		16 20	25 30	20 20	53 60	25 30	25 25	LP61	UTN16-1	RS61K	D61	PS61	-	NY3	AX612	RA508	NY2.5	MO830	NY5	1604 ..
M	MTWN R/L 16CA-16 MTWN R/L 20CA-16		16 20	25 30	20 20	53 60	25 30	25 25	LP61	UTN16-1	RS61K	D61	-	MS61	NY3	AX612	RA508	NY2.5	MO830	NY5	1604 ..
C	CTWN R/L		See page - Siehe Seite - Se sida			B16-B17															

**PTSN R/L
MTSN R/L
CTSN R/L**

Recommendations
Empfehlungen
Rekommendationer

Page: Seite: **B12-B17**
Sida:

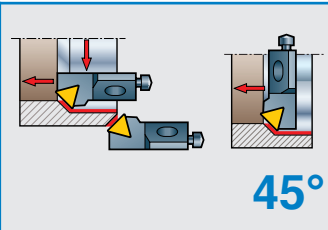
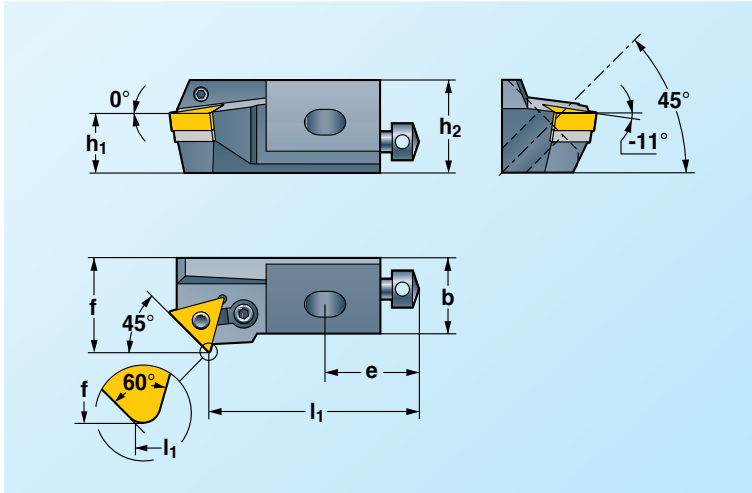
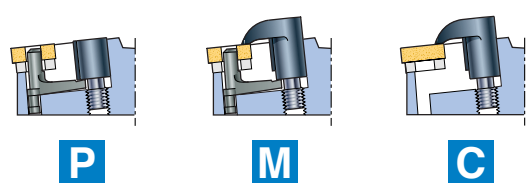



The drawing shows right-hand version. Left-hand version reversed.
Die Zeichnung zeigt Rechtsausführung. Linksausführung umgekehrt.
Ritningen visar högerutförande. Vänsterutförande spegelvänt.

			h_1	h_2	b	l_1	e	f													TNMA * TNMG TNMM Page: Seite: B172-B178 Sida:
P	PTSN R/L 16CA-16 PTSN R/L 20CA-16		16 20	25 30	20 20	53 60	25 30	25 25	LP61	UTN16-1	RS61K	D61	PS61	-	NY3	AX612	RA508	NY2.5	MO830	NY5	1604 ..
M	MTSN R/L 16CA-16 MTSN R/L 20CA-16		16 20	25 30	20 20	53 60	25 30	25 25	LP61	UTN16-1	RS61K	D61	-	MS61	NY3	AX612	RA508	NY2.5	MO830	NY5	1604 ..
C	CTSN R/L		See page - Siehe Seite - Se sida			B16-B17															

*  Selection of cutting geometry page:
Wahl der Schneidgeometrie, Seite: **B27-B39**
Val av skärgeometri, sida:

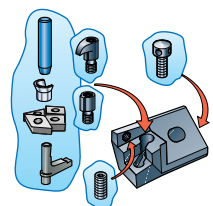

Ordering example:
Bestellbeispiel: **PTSNR 16CA-16**
Beställningsexempel:

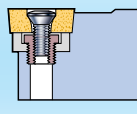

Spare parts shown in the coloured columns are supplied assembled in each tool.
Die in den farbigen Spalten aufgeführten Ersatzteile sind in den Werkzeugen montiert.
Reservdelar i de färgade kolumnerna ingår monterade i varje verktyg.

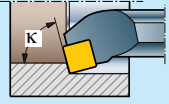

B

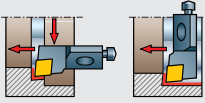
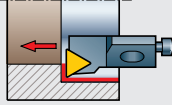
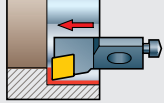
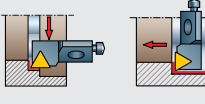
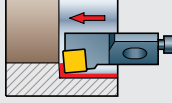
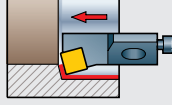
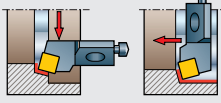
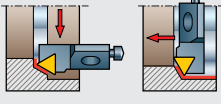
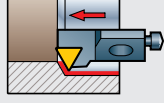
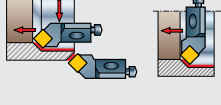
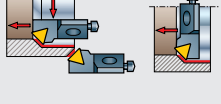
							Page Seite Sida
		6	8	10	12	16	
 95°	SCLC R/L			09	12		B140
 90°	STFC R/L	06	09	11	16	16	B140
 90°	SCFC R/L			09	12		B141
 90°	STGC R/L	06	09	11	16	16	B141
 85°	SSYC R/L			09	12	12	B142
 75°	SSKC R/L			09	12	12	B142
 75°	SSRC R/L			09	12		B143
 60°	STTC R/L	06	09	11	16	16	B143
 60°	STWC R/L	06	09	11	16	16	B144
 45°	SSSC R/L			09	12		B144
 45°	STSC R/L	06	09	11	16	16	B145

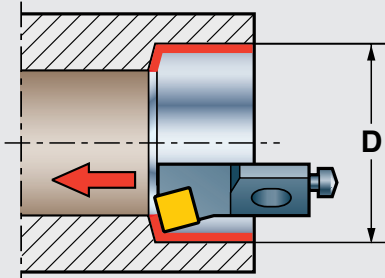
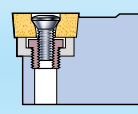
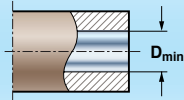
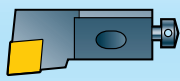

Size Grösse Storlek	06 CA	08 CA	10 CA	12 CA	16 CA
Type	-	-	SSKC	SSKC	SSKC
Typ	-	-	SSSC	SSSC	-
Typ	-	-	SSYC	SSYC	SSYC
	-	-	SCLC	SCLC	-
	-	-	SCFC	SCFC	-
	STFC	STFC	STFC	STFC	STFC
	STSC	STSC	STSC	STSC	STSC
	STWC	STWC	STWC	STWC	STWC
D-min	20	25	40	50	60

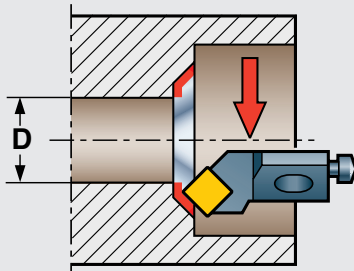

Size Grösse Storlek	06 CA	08 CA	10 CA	12 CA	16 CA
Type	-	-	SSRC	SSRC	-
Typ	-	-	SSSC	SSSC	-
Typ	-	-	SCLC	SCLC	-
	STGC	STGC	STGC	STGC	STGC
	STSC	STSC	STSC	STSC	STSC
	STTC	STTC	STTC	STTC	STTC
D-min	20	25	40	50	60

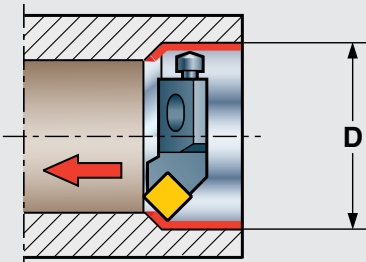

Size Grösse Storlek	06 CA	08 CA	10 CA	12 CA	16 CA
Type	-	-	SSRC	SSRC	-
Typ	-	-	SSSC	SSSC	-
Typ	-	-	SCLC	SCLC	-
	STGC	STGC	STGC	STGC	STGC
	-	-	STSC	STSC	STSC
	STTC	STTC	STTC	STTC	STTC
D-min	30	37	55	75	75

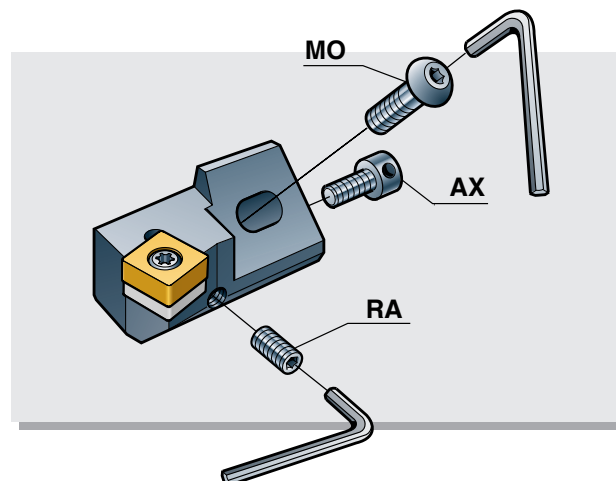

B

SCLC R/L

Recommendations
Empfehlungen
Rekommendationer

Page: Seite: Sida:

B12-B14, B18

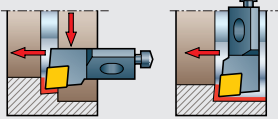



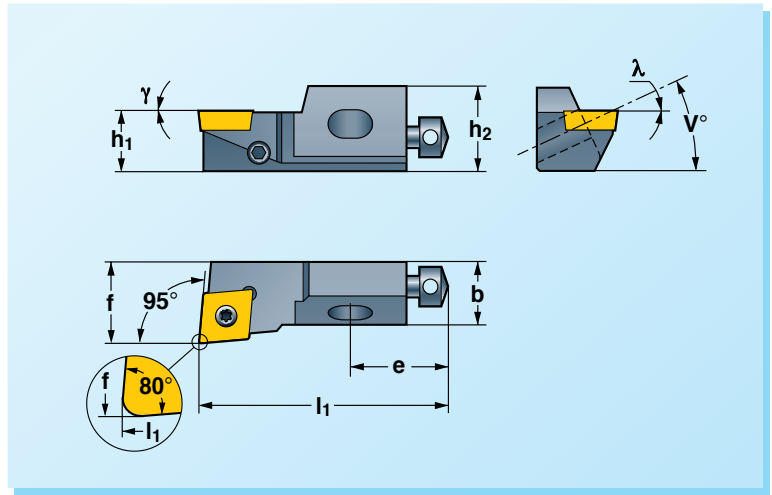





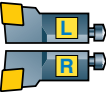
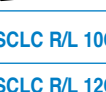

95°



B

S

The drawing shows right-hand version. Left-hand version reversed.
Die Zeichnung zeigt Rechtsausführung. Linksausführung umgekehrt.
Ritningen visar högerutförande. Vänsterutförande spegelvänt.

 	h_1	h_2	b	l_1	e	f	v	γ	λ	 torx	        	CCMW CCMT CCXT Page: Seite: Sida: B179-B184								
	SCLC R/L 10CA-09	10	15	11	50	20	14	20°	0°	0°	FTX153507	NY15X	-	-	-	AX508	RA408	NY2	MO618	NY4
SCLC R/L 12CA-12	12	20	15	55	20	20	20°	0°	0°	FTX154510	NY15X	-	-	-	AX508	RA412	NY2	MO622	NY4	1204 ..

STFC R/L

Recommendations
Empfehlungen
Rekommendationer

Page: Seite: Sida:

B12-B14, B18

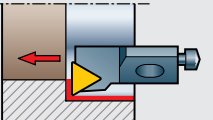



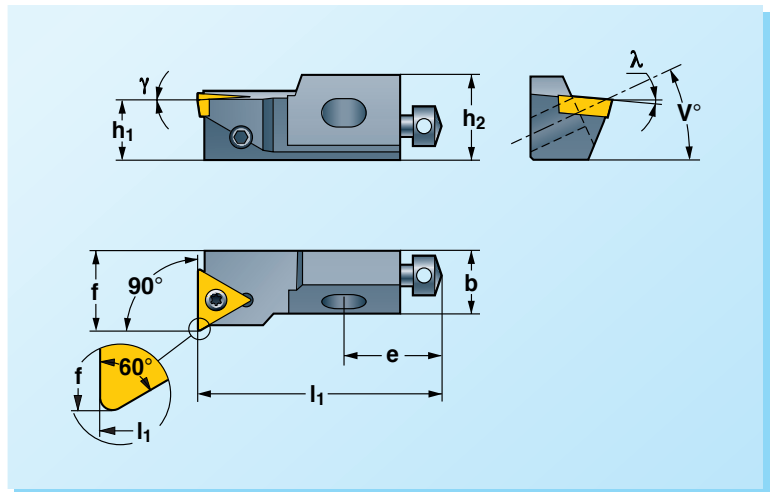





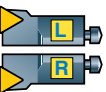



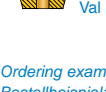

90°



S

The drawing shows right-hand version. Left-hand version reversed.
Die Zeichnung zeigt Rechtsausführung. Linksausführung umgekehrt.
Ritningen visar högerutförande. Vänsterutförande spegelvänt.

    	h_1	h_2	b	l_1	e	f	v	γ	λ	 torx	       	TCMW TCMT TCGT Page: Seite: Sida: B179-B184								
	STFC R/L 06CA-06	6	8,5	6	25	12	8	20°	0°	-6°	FTX062005	NY6X	-	-	-	AX305	RA304	NY1.5	MO3509	NY2
STFC R/L 08CA-09	8	11	7	32	17	10	20°	0°	-6°	FTX072206	NY7X	-	-	-	AX309	RA304	NY1.5	MO410	NY2.5	0902 ..
STFC R/L 10CA-11	10	15	11	50	20	14	20°	0°	0°	FTX072507	NY7X	-	-	-	AX508	RA408	NY2	MO618	NY4	1102 ..
STFC R/L 12CA-16	12	20	15	55	20	20	20°	0°	0°	FTX153512	NY15X	-	-	-	AX508	RA412	NY2	MO622	NY4	16T3 ..
STFC R/L 16CA-16	16	21	20	63	25	25	45°	0°	0°	FTX153514	NY15X	UTC16	RSM508	NY3,5	AX612	RA512	NY2.5	MO830	NY5	

*  Selection of cutting geometry page:
Wahl der Schneidgeometrie, Seite:
Val av skärgeometri, sid:

B27-B39

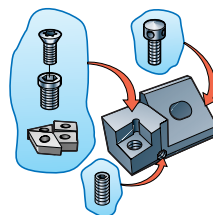

Spare parts shown in the coloured columns are supplied assembled in each tool.

Die in den farbigen Spalten aufgeführten Ersatzteile sind in den Werkzeugen montiert.

Reservdelar i de färgade kolumnerna ingår monterade i varje verktyg.

Ordering example:
Bestellbeispiel: **STFCR 10CA-11**
Beställningsexempel: