			Page Seite Sida
			10	12,5	
	<b>90°</b>	<b>STFCR/L</b>	11 16		B128
	<b>75°</b>	<b>SSKCR/L</b>	12	09	B128
	<b>60°</b>	<b>STTCR/L</b>	16	11	B129
	<b>60°</b>	<b>STWCR/L</b>	16	11	B129
	<b>45°</b>	<b>SSSCR/L</b>		09 12	B130
	<b>45°</b>	<b>STSCR/L</b>	16	11	B130

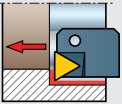

Radial adjustment Radiale Verstellbarkeit Radiell ställbarhet	2 mm	1 mm
Size Grösse Storlek	10 CM	13 CM
Type Typ Typ	SSKC SSSC STFC STSC STTC STWC	SSKC SSSC STFC STSC STTC STWC
D-min	32	45

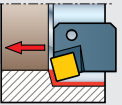

Size Grösse Storlek	10 CM	13 CM
Type Typ Typ	SSSC STSC STTC	SSSC STSC STTC
D-min	55	75

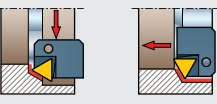
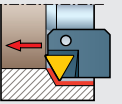
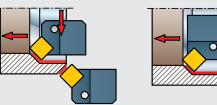
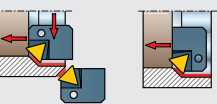
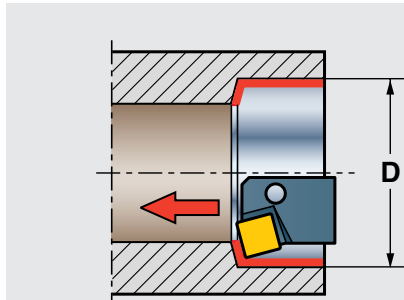
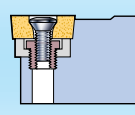
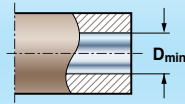
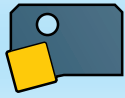
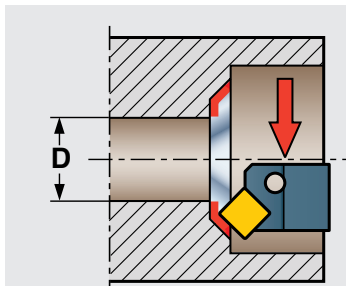
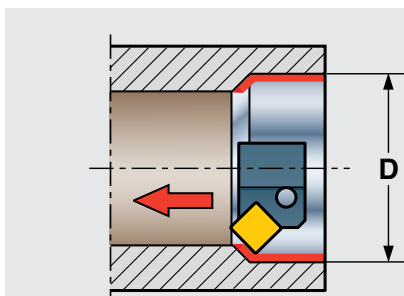

Size Grösse Storlek	10 CM	13 CM
Type Typ Typ	SSSC STSC STTC	SSSC STSC STTC
D-min	40	50

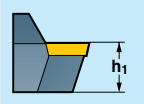

10 CM

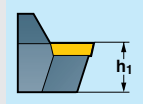
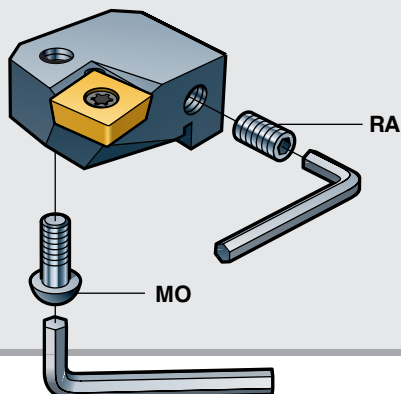

13 CM

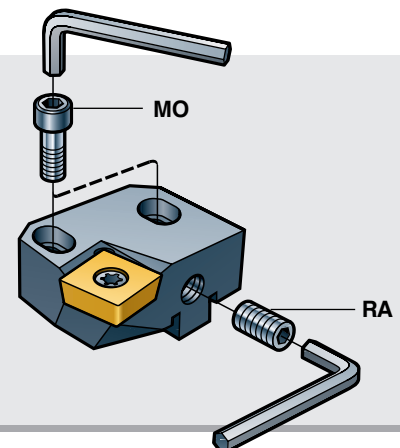

**STFC R/L**

Recommendations  
Empfehlungen  
Rekommendationer

Page: Seite: Sida:  
**B9-B11, B15**

**90°**

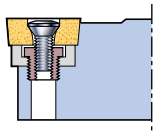











**S**

The drawing shows right-hand version. Left-hand version reversed.  
Die Zeichnung zeigt Rechtsausführung. Linksausführung umgekehrt.  
Ritningen visar högerutförande. Vänsterutförande spegelvänt.

Size 10 CM  
Grösse 10 CM  
Storlek 10 CM

Size 13 CM  
Grösse 13 CM  
Storlek 13 CM

			$h_1$	$l_1$	$f$	$\lambda$							TCMW*  <small>B170</small>	TCMT 	TCGT 	Page: Seite: Sida: <b>B143-B146</b>
<b>STFCR/L 10CMX11</b>			10	21,5	18	-4°	FTX072507	NY7X	RA508	NY2.5	MO510	NY3	1102 ..			
<b>STFCR/L 13CMX16</b>			12,5	21	26	-4°	FTX153510	NY15X	RA508	NY2.5	MO516	NY3	16T3 ..			

**SSKC R/L**

Recommendations  
Empfehlungen  
Rekommendationer

Page: Seite: Sida:  
**B9-B11, B15**

**75°**

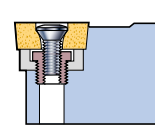



**S**

The drawing shows right-hand version. Left-hand version reversed.  
Die Zeichnung zeigt Rechtsausführung. Linksausführung umgekehrt.  
Ritningen visar högerutförande. Vänsterutförande spegelvänt.

Size 10 CM  
Grösse 10 CM  
Storlek 10 CM

Size 13 CM  
Grösse 13 CM  
Storlek 13 CM

			$h_1$	$l_1$	$f$	$\lambda$							SCMW*  <small>B170</small>	SCMT 	SCGT 	Page: Seite: Sida: <b>B143-B146</b>
<b>SSKCR/L 10CMX09T</b>			10	21,5	18	-4°	FTX153510	NY15X	RA508	NY2.5	MO510	NY3	09T3 ..			
<b>SSKCR/L 13CMX12</b>			12,5	18	26	-4°	FTX154512	NY15X	RA508	NY2.5	MO516	NY3	1204 ..			

**STTC R/L**

Recommendations  
Empfehlungen  
Rekommendationer

Page: Seite: Sida:  
**B9-B11, B15**

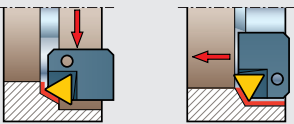

**60°**

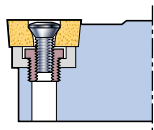









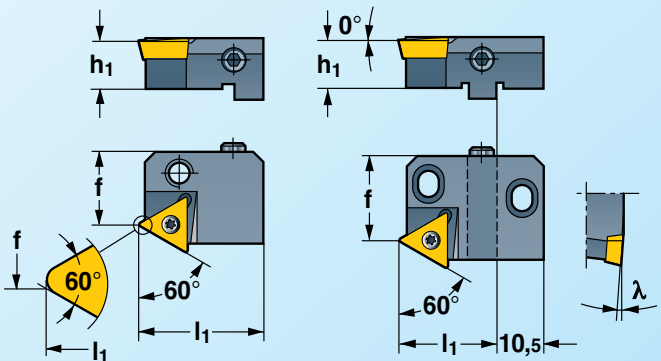



**S**

The drawing shows right-hand version. Left-hand version reversed.  
Die Zeichnung zeigt Rechtsausführung. Linksausführung umgekehrt.  
Ritningen visar högerutförande. Vänsterutförande spegelvänt.

Size 10 CM  
Grösse 10 CM  
Storlek 10 CM

Size 13 CM  
Grösse 13 CM  
Storlek 13 CM



			$h_1$	$l_1$	$f$	$\lambda$							TCMW*  <sup>B170</sup>	TCMT 	TCGT 	Page: Seite: Sida: <b>B143-B146</b>	
<b>STTCR/L 10CMX11</b>			10	23	13,5	-4°	FTX072507	NY7X	RA508	NY2.5	MO510	NY3	1102 . .				
<b>STTCR/L 13CMX16</b>			12,5	21,5	18,8	-4°	FTX153510	NY15X	RA508	NY2.5	MO516	NY3	16T3 . .				

**STWC R/L**

Recommendations  
Empfehlungen  
Rekommendationer

Page: Seite: Sida:  
**B9-B11, B15**

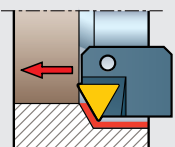

**60°**

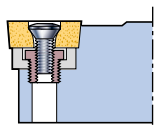







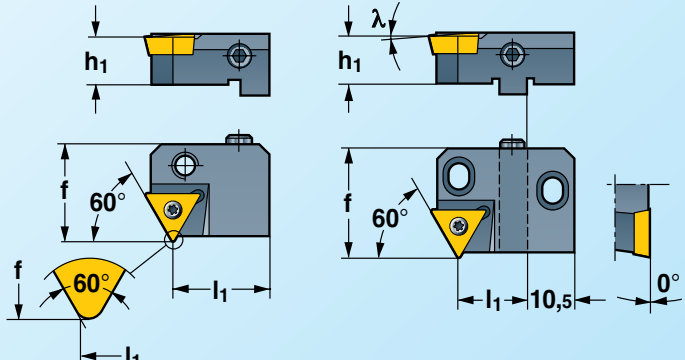

**S**

The drawing shows right-hand version. Left-hand version reversed.  
Die Zeichnung zeigt Rechtsausführung. Linksausführung umgekehrt.  
Ritningen visar högerutförande. Vänsterutförande spegelvänt.

Size 10 CM  
Grösse 10 CM  
Storlek 10 CM

Size 13 CM  
Grösse 13 CM  
Storlek 13 CM



			$h_1$	$l_1$	$f$	$\lambda$							TCMW*  <sup>B170</sup>	TCMT 	TCGT 	Page: Seite: Sida: <b>B143-B146</b>	
<b>STWCR/L 10CMX11</b>			10	20	18	-4°	FTX072507	NY7X	RA508	NY2.5	MO510	NY3	1102 . .				
<b>STWCR/L 13CMX16</b>			12,5	17	26	-4°	FTX153510	NY15X	RA508	NY2.5	MO516	NY3	16T3 . .				

\*  Selection of cutting geometry page:  
Wahl der Schneidgeometrie, Seite: **B22-B26**  
Val av skärgeometri, sid:

Ordering example:  
Bestellbeispiel: **STWCR 10CMX11**  
Beställningsexempel:

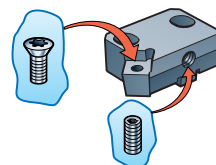

Spare parts shown in the coloured columns are supplied assembled in each tool.

Die in den farbigen Spalten aufgeführten Ersatzteile sind in den Werkzeugen montiert.

Reservdelar i de färgade kolumnerna ingår monterade i varje verktyg.

**SSSC R/L**

Recommendations  
Empfehlungen  
Rekommendationer

Page: Seite: Sida:  
**B9-B11, B15**

**45°**

Size 10 CM  
Grösse 10 CM  
Storlek 10 CM

Size 13 CM  
Grösse 13 CM  
Storlek 13 CM

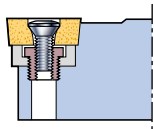

**S**

The drawing shows right-hand version. Left-hand version reversed.  
Die Zeichnung zeigt Rechtsausführung. Linksausführung umgekehrt.  
Ritningen visar högerutförande. Vänsterutförande spegelvänt.

	$h_1$	$l_1$	$f$	$\lambda$							SCMW* <sup>B170</sup> SCMT SCGT	Page: Seite: Sida: <b>B143-B146</b>
 						torx						
<b>SSSCR/L 10CMX09T</b>	10	22,5	18	0°	FTX153510	NY15X	RA508	NY2.5	MO510	NY3	09T3 . .	
<b>SSSCR/L 13CMX12</b>	12,5	20	26	0°	FTX154512	NY15X	RA508	NY2.5	MO516	NY3	1204 . .	

**STSC R/L**

Recommendations  
Empfehlungen  
Rekommendationer

Page: Seite: Sida:  
**B9-B11, B15**

**45°**

Size 10 CM  
Grösse 10 CM  
Storlek 10 CM

Size 13 CM  
Grösse 13 CM  
Storlek 13 CM

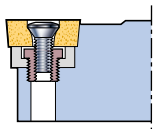

**S**

The drawing shows right-hand version. Left-hand version reversed.  
Die Zeichnung zeigt Rechtsausführung. Linksausführung umgekehrt.  
Ritningen visar högerutförande. Vänsterutförande spegelvänt.

	$h_1$	$l_1$	$f$	$\lambda$							TCMW* <sup>B170</sup> TCMT TCGT	Page: Seite: Sida: <b>B143-B146</b>
 						torx						
<b>STSCR/L 10CMX11</b>	10	17,5	18	-4°	FTX072507	NY7X	RA508	NY2.5	MO510	NY3	1102 . .	
<b>STSCR/L 13CMX16</b>	12,5	11	26	-4°	FTX153510	NY15X	RA508	NY2.5	MO516	NY3	16T3 . .	

\* Selection of cutting geometry page:  
 Wahl der Schneidgeometrie, Seite:  
 Val av skärgeometri, sid: **B22-B26**

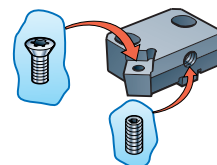

Spare parts shown in the coloured columns are supplied assembled in each tool.

Die in den farbigen Spalten aufgeführten Ersatzteile sind in den Werkzeugen montiert.

Reservdelar i de färgade kolumnerna ingår monterade i varje verktyg.

Ordering example:  
Bestellbeispiel: **SSSCR 13CMX12**  
Beställningsexempel: