

Built-in measurement for MIRCONA insert seat type C  
 Einbaumassen für MIRCONA Schneidsitze Typ C  
 Inbyggnadsmått för MIRCONA skärläge typ C

Size  
 Grösse 06 CM  
 Storlek

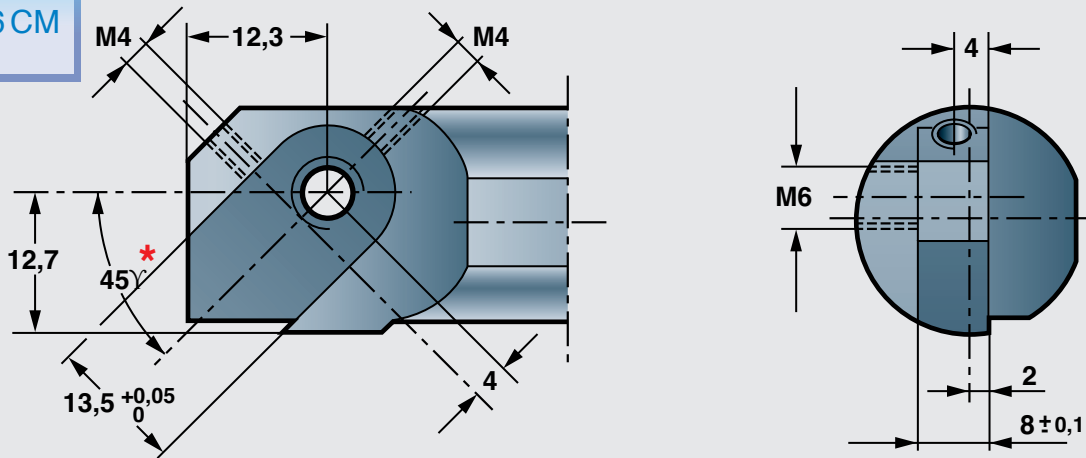

Size  
 Grösse 07 CM  
 Storlek

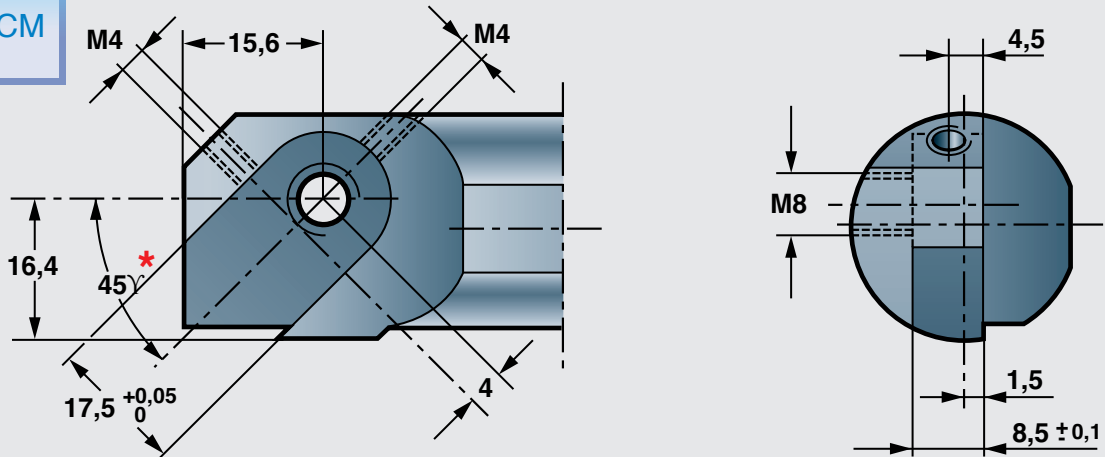

\* The angle 45° of the recess gives the tool an approach angle of 75°. By modifying the angle of the recess, other approach angles can be achieved.

\* Der Winkel 45° der Aussparung gibt dem Werkzeug einen Stellwinkel von 75°. Durch die Modifizierung des Aussparungswinkels können andere Stellwinkel erreicht werden.

\* Vinkeln 45° hos urtaget ger verktyget en ställvinkel på 75°. Genom att förändra vinkeln hos urtaget kan andra ställvinklar erhållas.

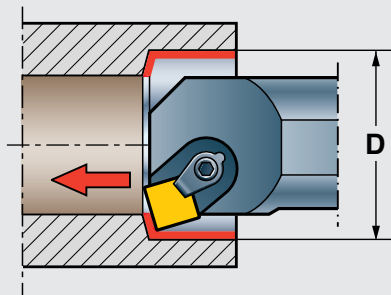
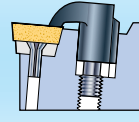
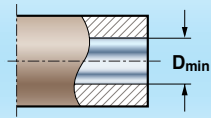
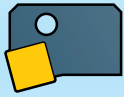

Size Grösse Storlek	06 CM	07 CM
Type Typ Typ	CSKP	CSKP
D-min	26	32

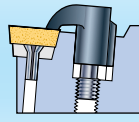
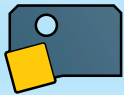

### CSKP R/L

Recommendations  
Empfehlungen  
Rekommendationer

Page: Seite: Sida:

**B9-B11, B16**

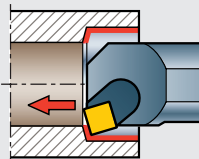



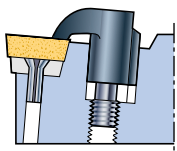



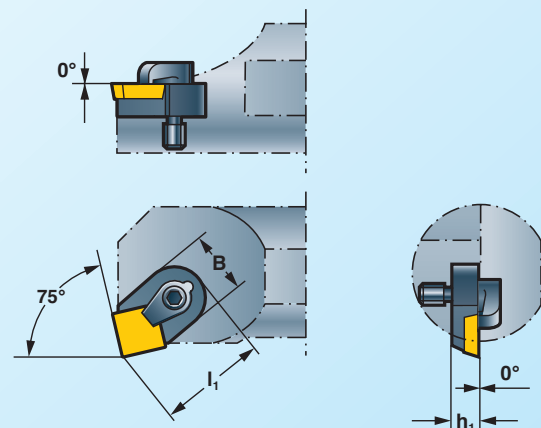

**75°**



**C**



The drawing shows right-hand version. Left-hand version reversed.  
Die Zeichnung zeigt Rechtsausführung. Linksausführung umgekehrt.  
Ritningen visar högerutförande. Vänsterutförande spegelvänt.

			$h_1$	$l_1$	B				SPGN SPUN SPGR SPMR	   	Page: Seite: Sida: <b>B147</b>
<b>CSKPR/L 06CMX09</b>			6	25	13,5	SH51	6S61K	NY 3	0903 . .		
<b>CSKPR/L 07CMX12</b>			7	32	17,5	SH52K	6S62K	NY4	1203 . .		

Ordering example:  
Bestellbeispiel: **CSKPR 06CMX09**  
Beställningsexempel:

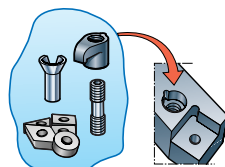

Spare parts shown in the coloured columns are supplied assembled in each tool.

Die in den farbigen Spalten aufgeführten Ersatzteile sind in den Werkzeugen montiert.

Reservdelar i de färgade kolumnerna ingår monterade i varje verktyg.