					Page Seite Sida
		8	10	12	16	20	
 90°	CTAC R/L		06				B100
	CTAP R/L			09	11	11	
 60°	CTEC R/L		06				B100
	CTEP R/L			09	11	11	
 45°	CTDC R/L		06				B101
	CTDP R/L			09	11	11	

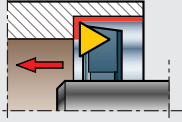

CTAC R/L CTAP R/L

Recommendations
Empfehlungen
Rekommendationer

Page: Seite: Sida:

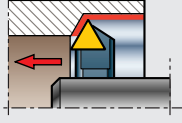
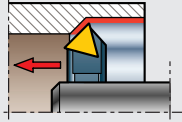
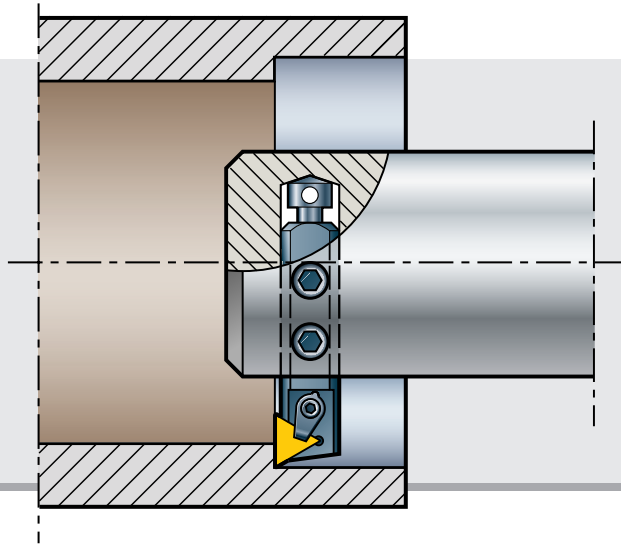

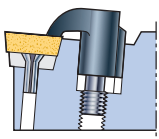
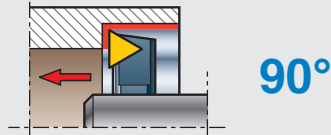



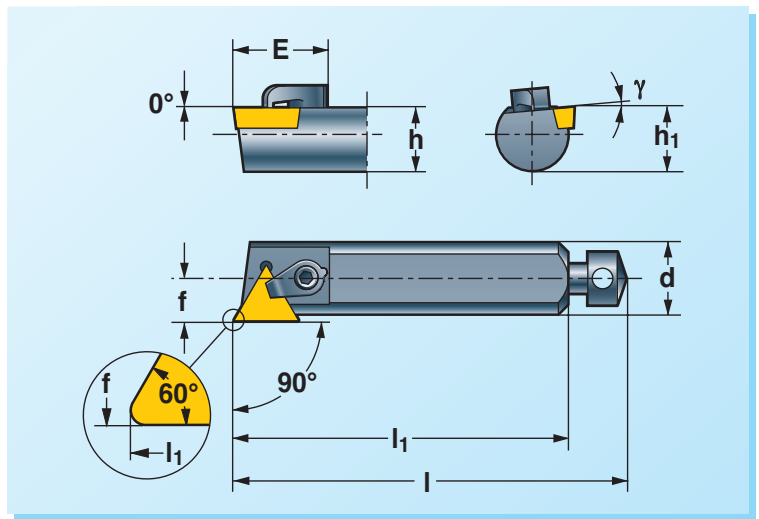

B9-B11, B16



C

The drawing shows right-hand version. Left-hand version reversed.
Die Zeichnung zeigt Rechtsausführung. Linksausführung umgekehrt.
Ritningen visar högerutförande. Vänsterutförande spegelvänt.



			$h=h_1$	d	l_{\min}	l_1	E	f	γ							TCGR TPGN TPGR TPMR	Page: Seite: Sida: B147
S08X-CTAC R/L 06 S10X-CTAP R/L 09			7 9	8 10	— —	30 50	14 15,2	4 5	2° 6°	—	—	SH49	6S-50K	NY1.5	—	0601 ... 0902 ...	
S12X-CTAP R/L 11 S16X-CTAP R/L 11			10,5 14	12 16	67 63 97 93	57 87	16,9 16	6,5 8,5	6° 6°	—	—	SH50M	6S-50M	NY2	AX508	1103 ...	
S20X-CTAP R/L 16			17	20	127 123	117	21,1	10,7	6°	U323S	RS2	SH51	6S61	NY3	AX508	1603 ...	

CTEC R/L CTEP R/L

Recommendations
Empfehlungen
Rekommendationer

Page: Seite: Sida:



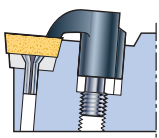
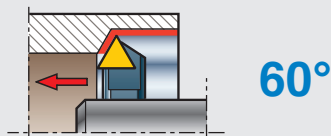



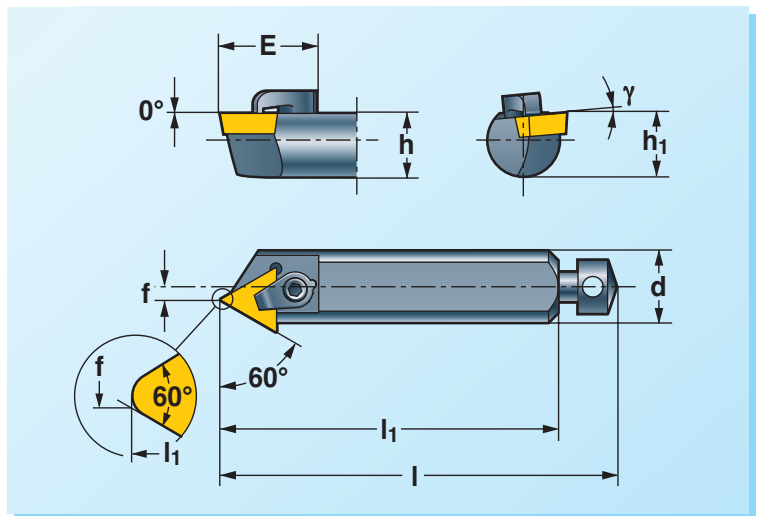

B9-B11, B16



C

The drawing shows right-hand version. Left-hand version reversed.
Die Zeichnung zeigt Rechtsausführung. Linksausführung umgekehrt.
Ritningen visar högerutförande. Vänsterutförande spegelvänt.



			$h=h_1$	d	l_{\min}	l_1	E	f	γ							TCGR TPGN TPGR TPMR	Page: Seite: Sida: B147
S08X-CTEC R/L 06 S10X-CTEP R/L 09			7 9	8 10	— —	30 50	14,5 16,7	1,4 1,5	2° 6°	—	—	SH49	6S-50K	NY1.5	—	0601 ... 0902 ...	
S12X-CTEP R/L 11 S16X-CTEP R/L 11			10,5 14	12 16	67 63 97 93	57 87	19 19	2,4 2,4	6° 6°	—	—	SH50M	6S-50M	NY2	AX508	1103 ...	
S20X-CTEP R/L 16			17	20	127 123	117	25	1,9	6°	U323S	RS2	SH51	6S61	NY3	AX508	1603 ...	

Ordering example:

Bestellbeispiel: **S12X-CTEP L 11**

Beställningsexempel:

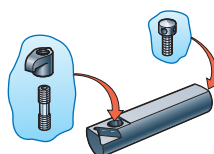

Spare parts shown in the coloured columns are supplied assembled in each tool.

Die in den farbigen Spalten aufgeführten Ersatzteile sind in den Werkzeugen montiert.

Reservdelar i de färgade kolumnerna ingår monterade i varje verktyg.

CTDC R/L
CTDP R/L

Recommendations
Empfehlungen
Rekommendationer

Page: Seite: Sida:

B9-B11, B16

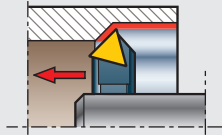

45°

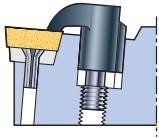

C

The drawing shows right-hand version. Left-hand version reversed.
Die Zeichnung zeigt Rechtsausführung. Linksausführung umgekehrt.
Ritningen visar högerutförande. Vänsterutförande spegelvänt.

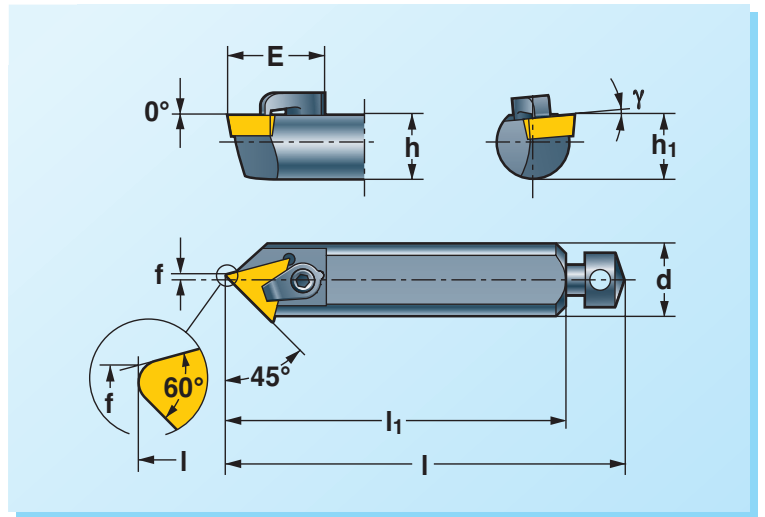

	$h=h_1$	d	l_{\max} l_{\min}	l_1	E	f	γ							TCGR TPGN TPGR TPMR	Page: Seite: Sida: B147
S08X-CTDC R/L 06 S10X-CTDP R/L 09	7 9	8 10	— —	30 50	15 16,8	0,2 0,6	2° 6°	—	—	SH49	6S-50K	NY1.5	—	0601 .. 0902 ..	
S12X-CTDP R/L 11 S16X-CTDP R/L 11	10,5 14	12 16	67 63 97 93	57 87	19,7 19,7	0,2 0,2	6° 6°	—	—	SH50M	6S-50M	NY2	AX508	1103 ..	
S20X-CTDP R/L 16	17	20	127 123	117	24,8	0,9	6°	U323S	RS2	SH51	6S61	NY3	AX508	1603 ..	

Ordering example:

Bestellbeispiel: **S10X-CTDP L 09**

Beställningsexempel:

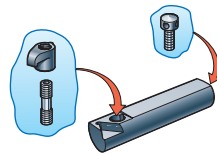

Spare parts shown in the coloured columns are supplied assembled in each tool.

Die in den farbigen Spalten aufgeführten Ersatzteile sind in den Werkzeugen montiert.

Reservdelar i de färgade kolumnerna ingår monterade i varje verktyg.